

図1

(a) 2次元ラドン変換

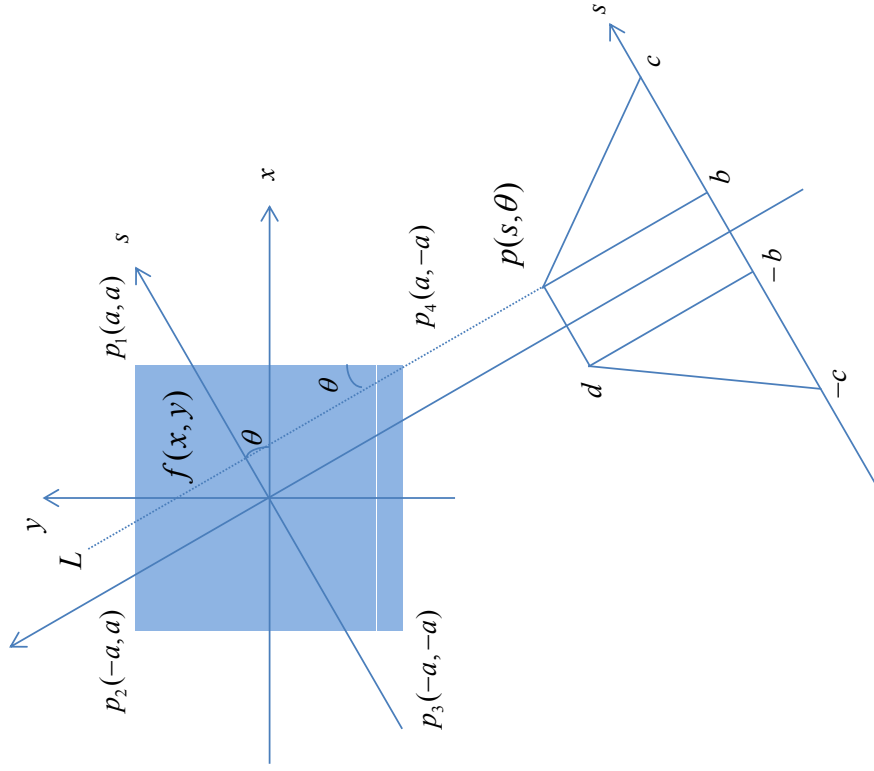

(b) 投影の収集

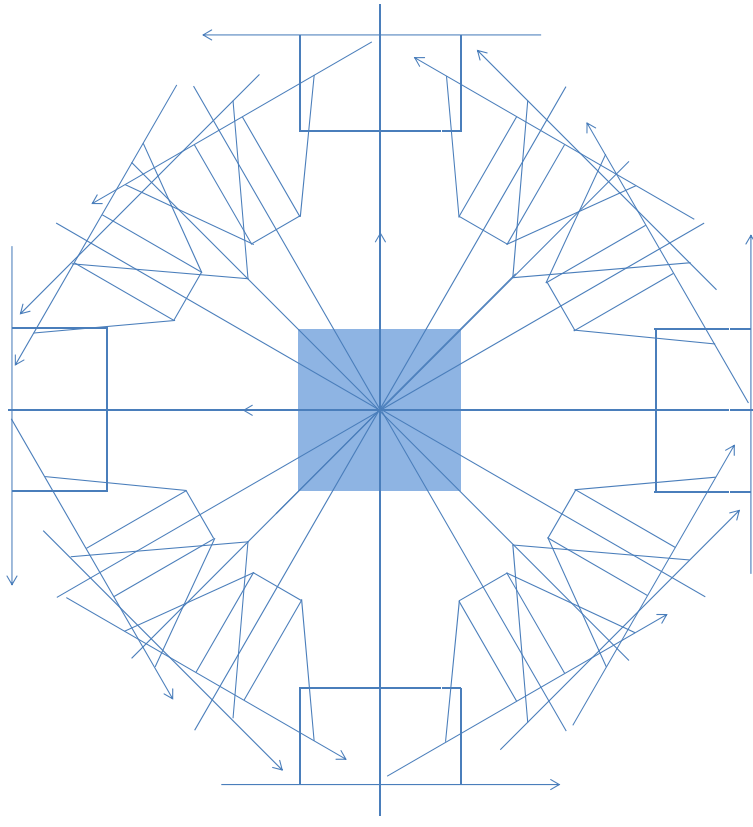

(a) 投影

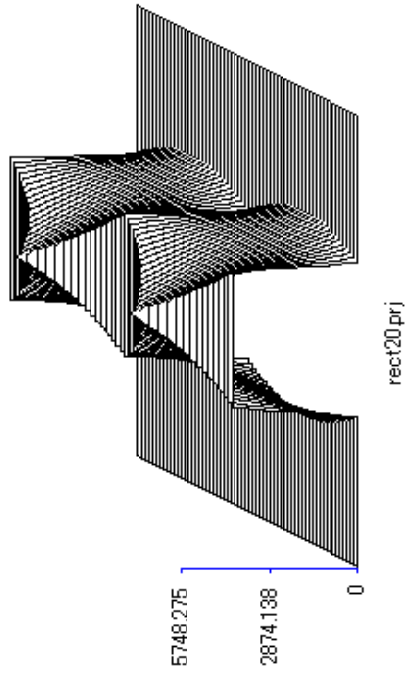

(b) Ram-Lak フィルタ

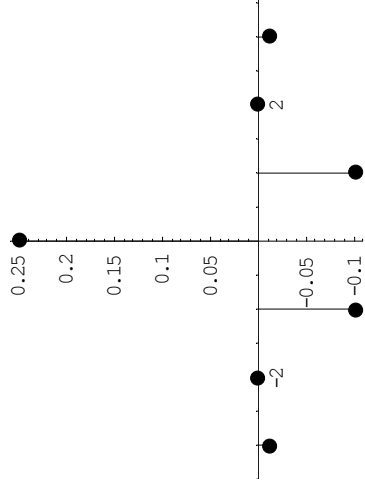

(c) フィルタ補正



图3



图4

2方向

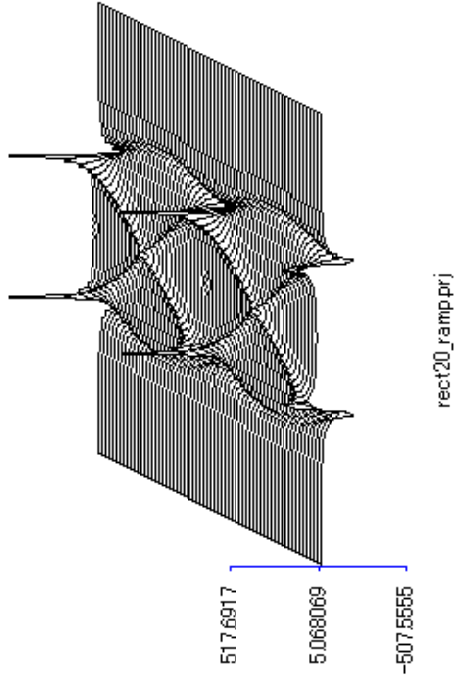

kukei20\_n2\_r.img

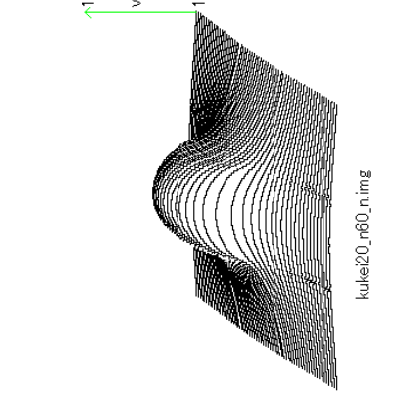
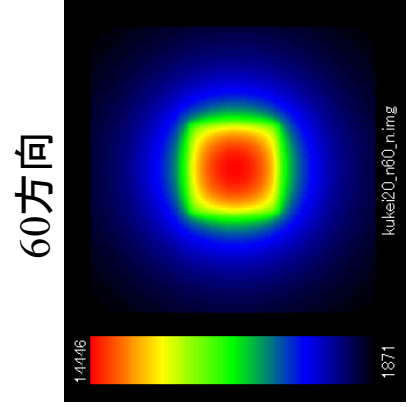
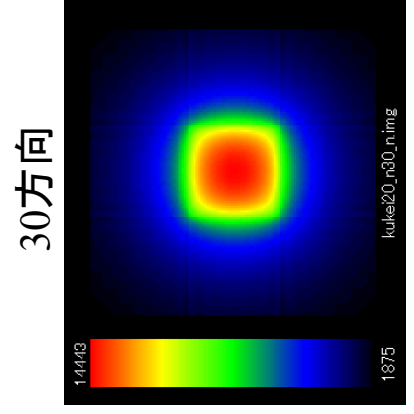
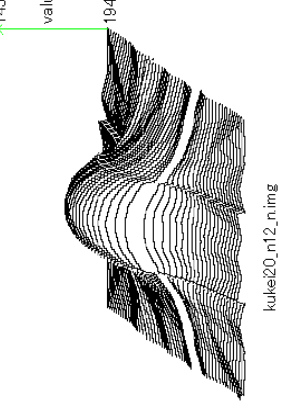
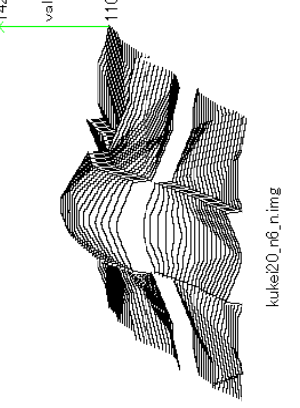
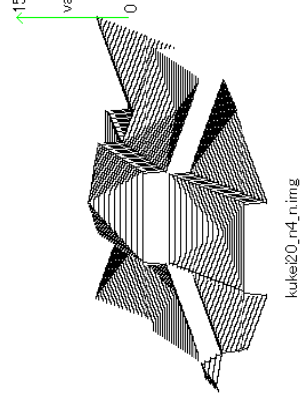
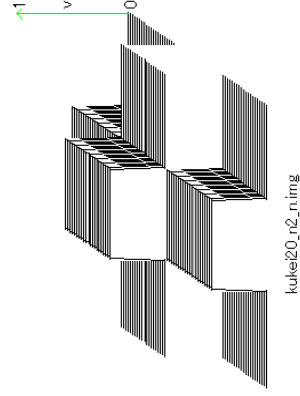
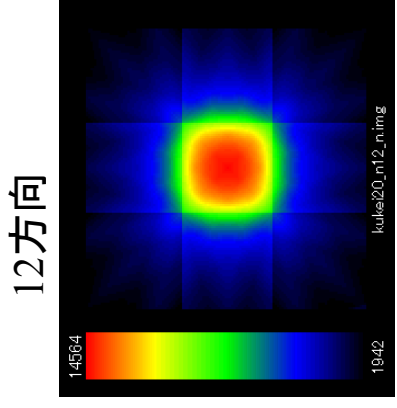
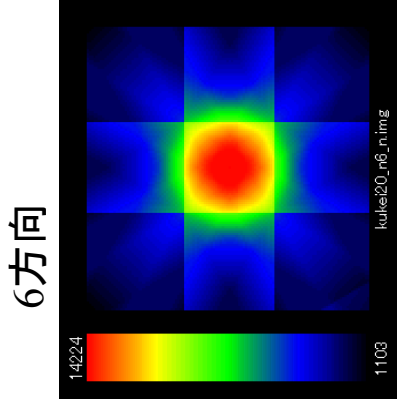
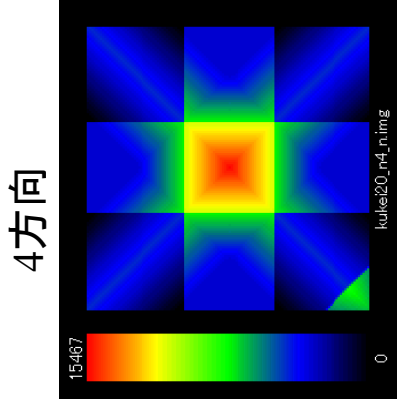
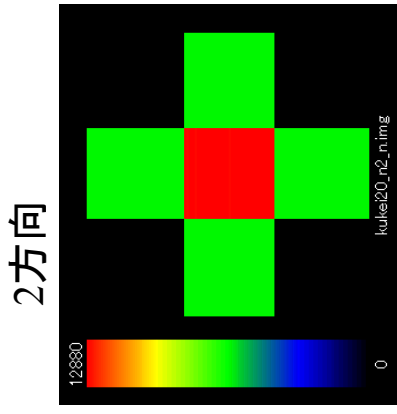
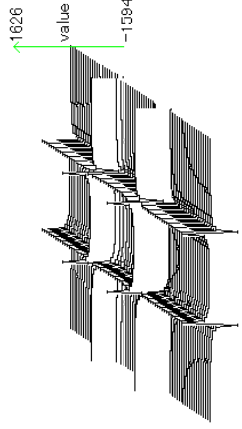
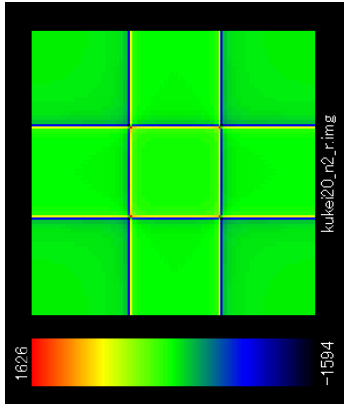
4方向

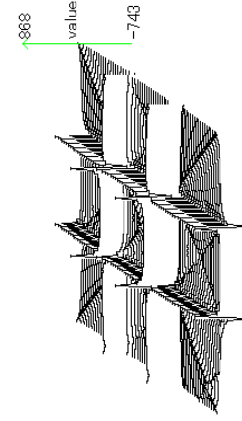
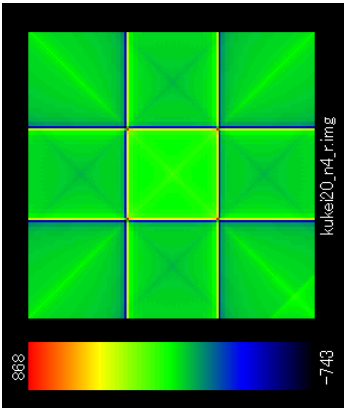

kukei20\_n4\_r.img

6方向

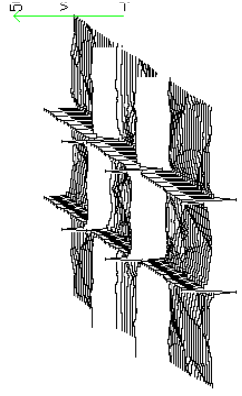
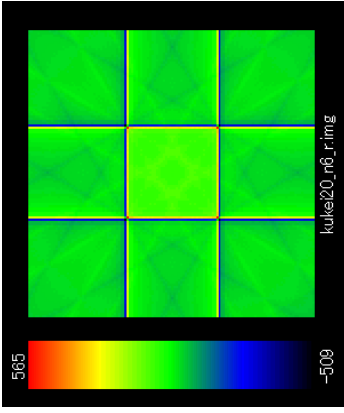

kukei20\_n6\_r.img

12方向

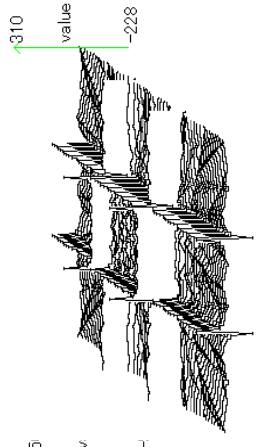
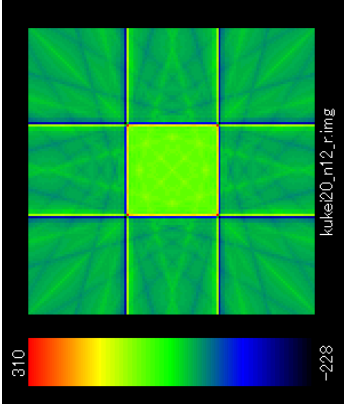

kukei20\_n12\_r.img

30方向

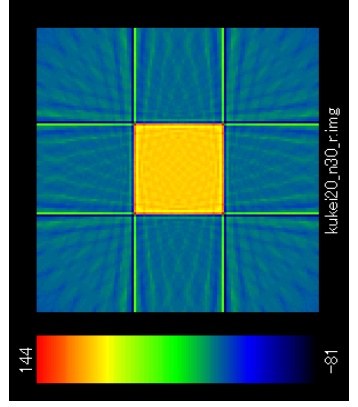

60方向

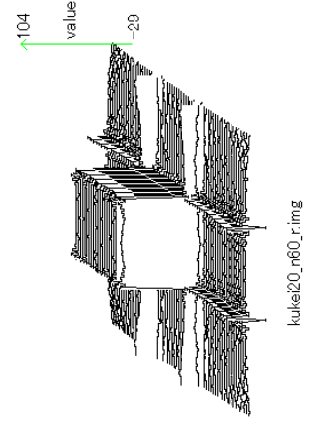
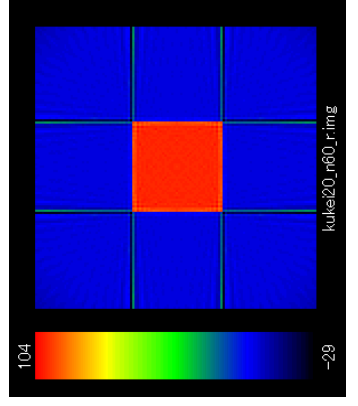

kukei20\_n60\_r.img

(a) 投影の微分  $\partial p(s, \theta) / \partial s$

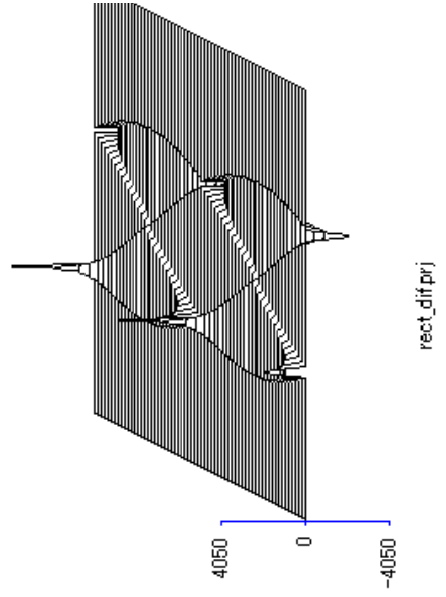

(b) フィルタ補正

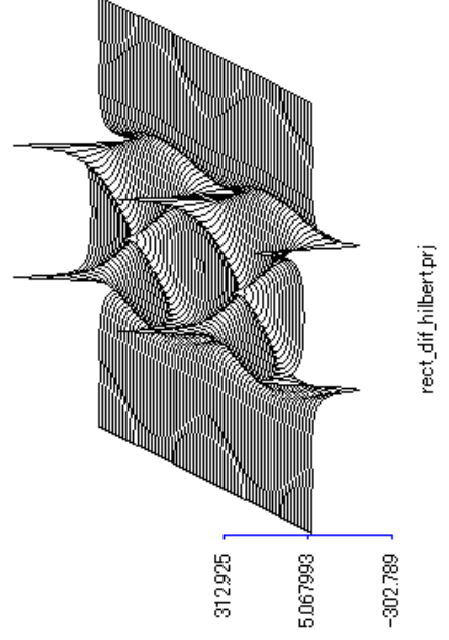

(c) 再構成画像

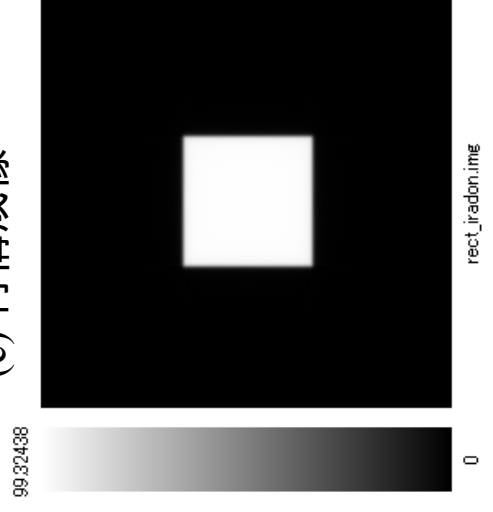



图7



# 逆投影

14400

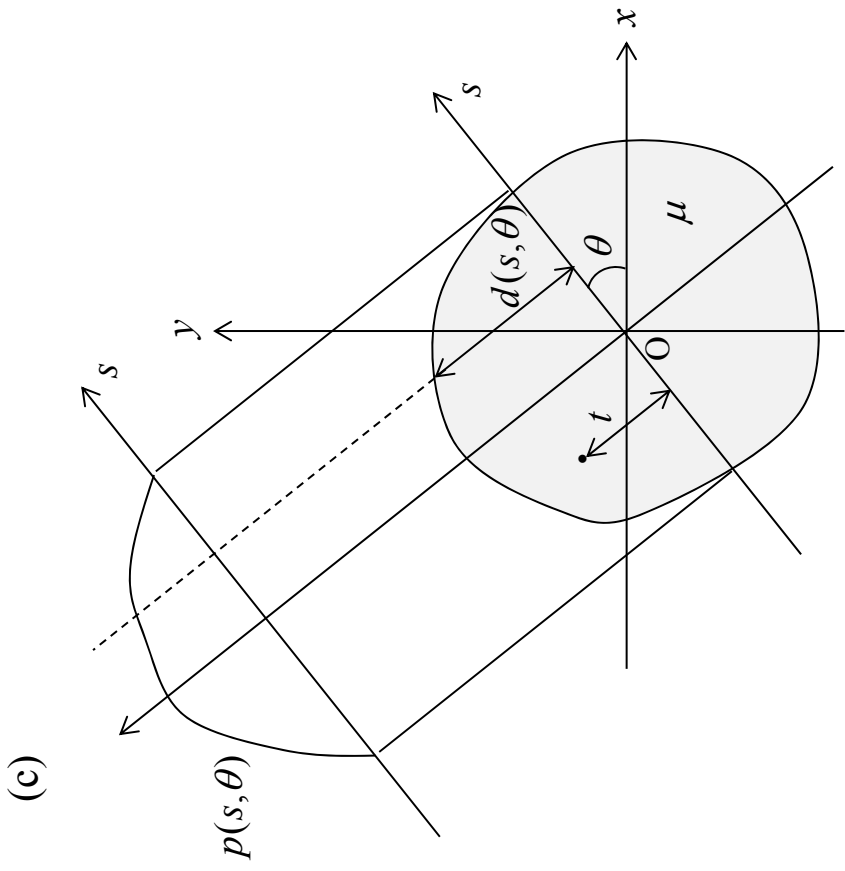
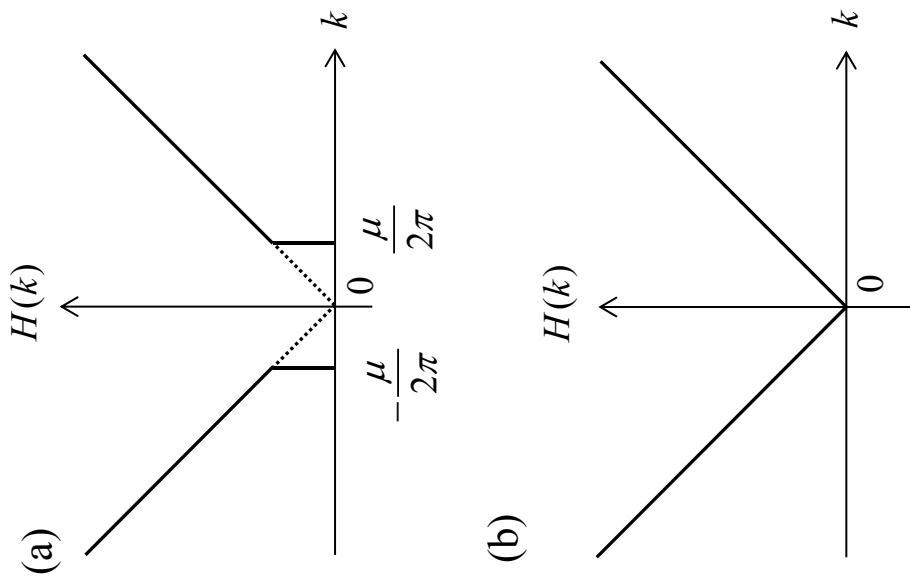
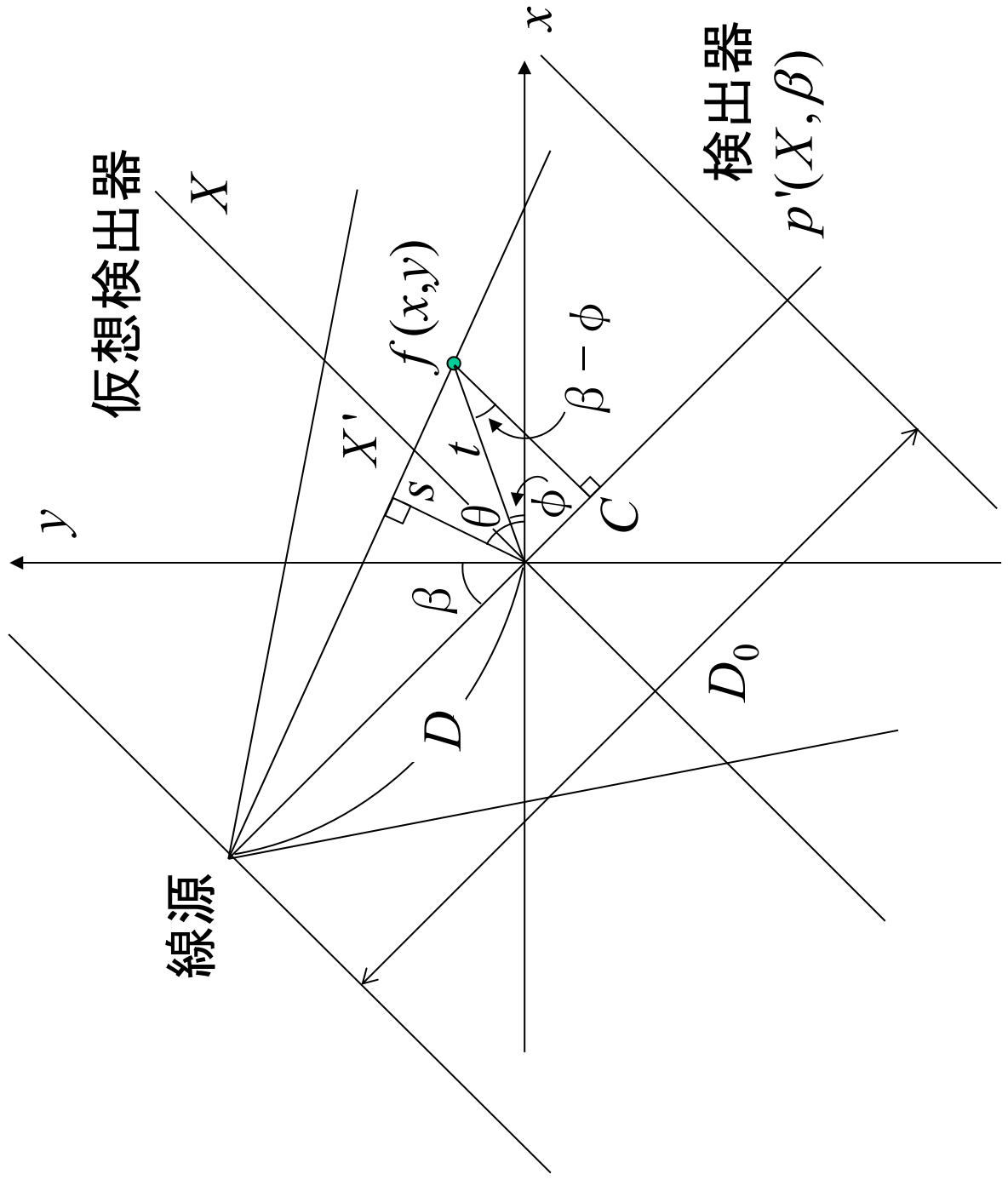
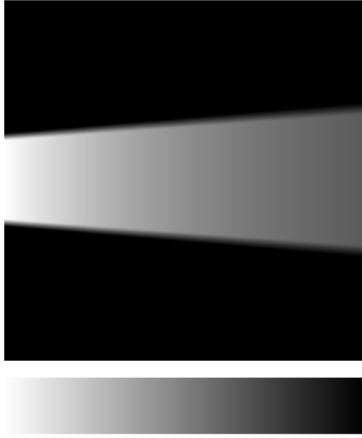

U

19694.82

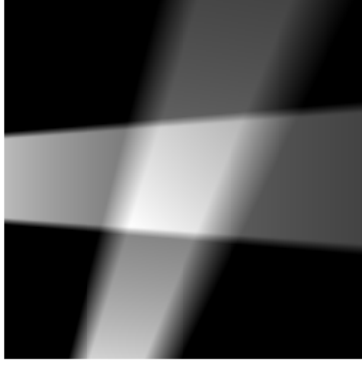

U

28269.53

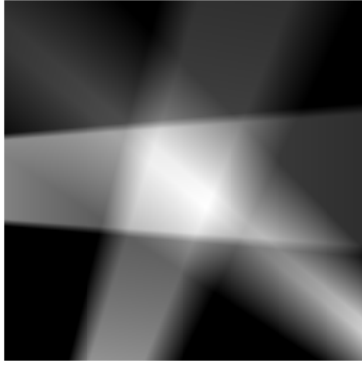

U

37457.78

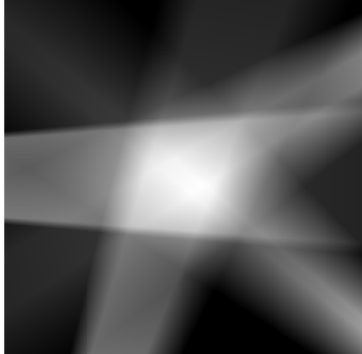

U

# フィルタ補正逆投影

1123.037

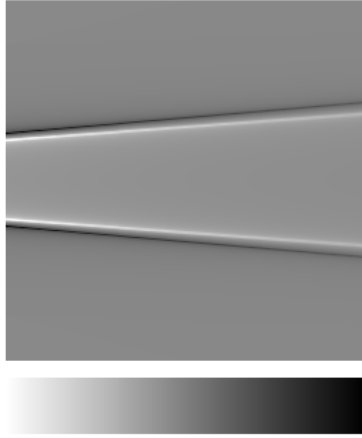

-1310.432

1123.037

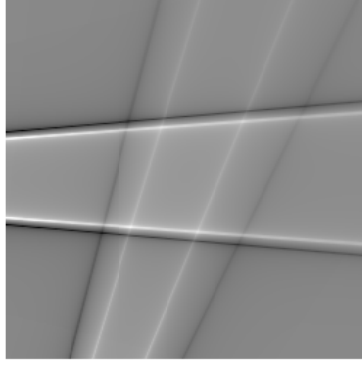

-1310.432

1110.277

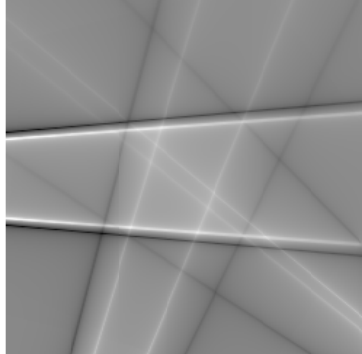

-1321.991

1132.458

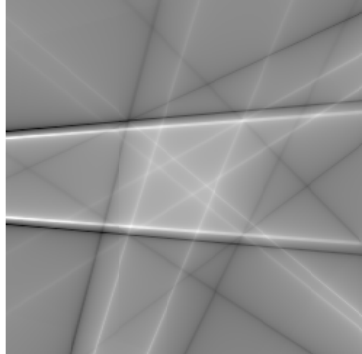

-1337.937



(a) Direct projection

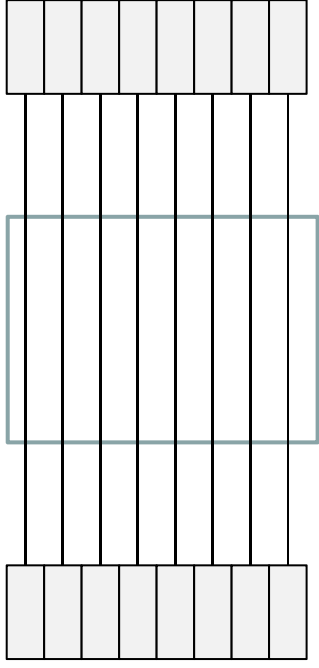

(b) Oblique projection

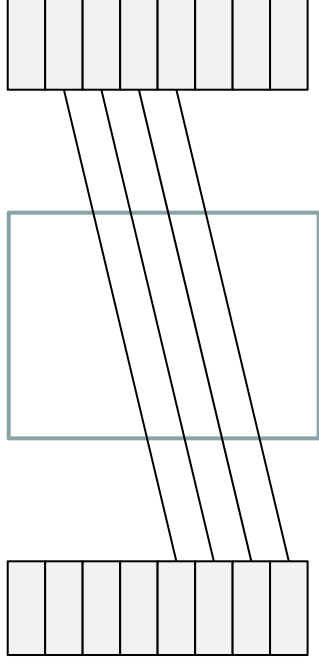

(c) Orlov's Sphere

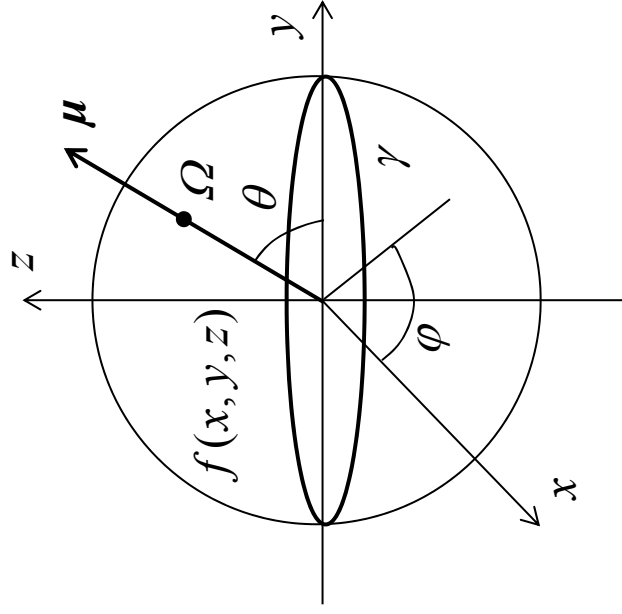

(d)  $\psi \leq \theta_{\max}$

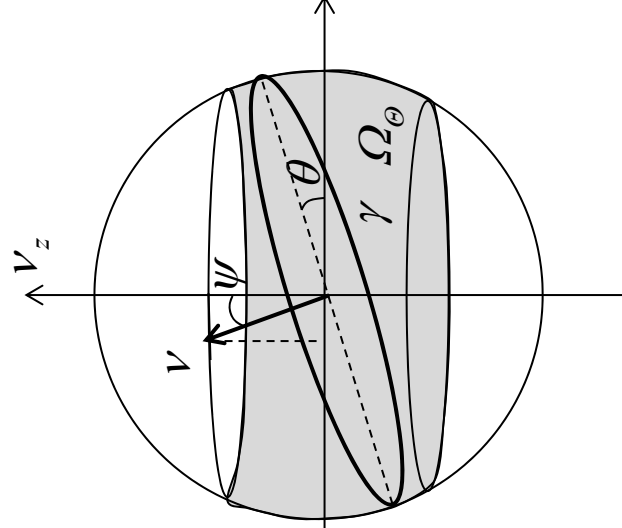

(e)  $\psi > \theta_{\max}$



図10



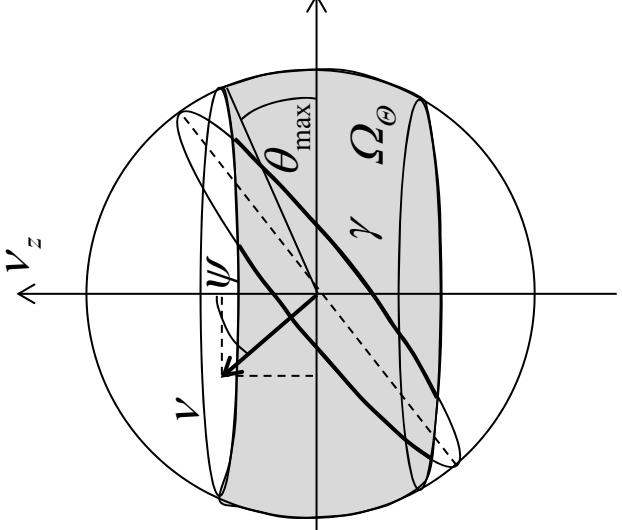
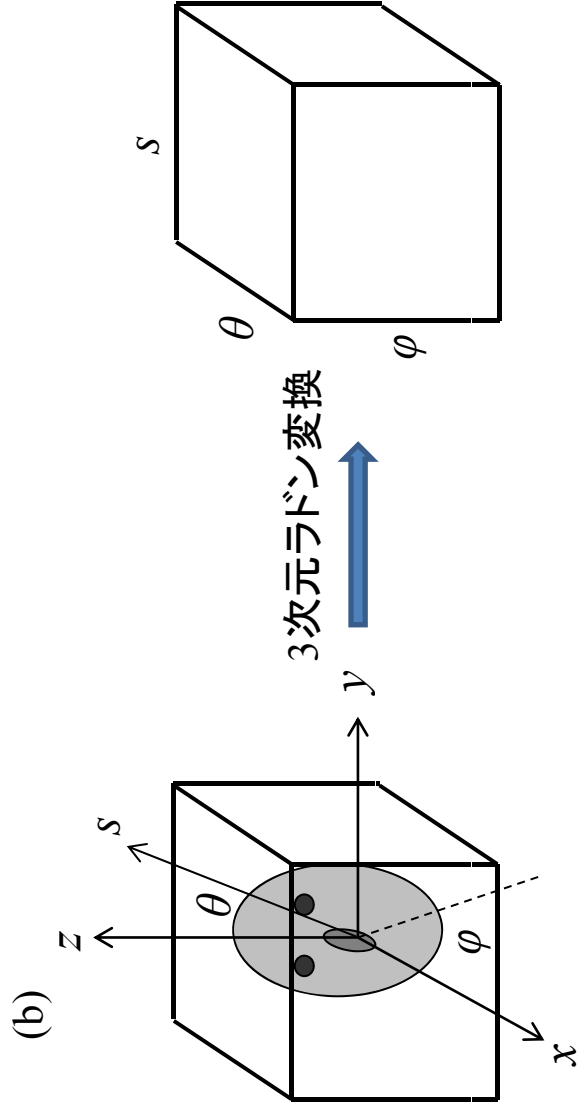
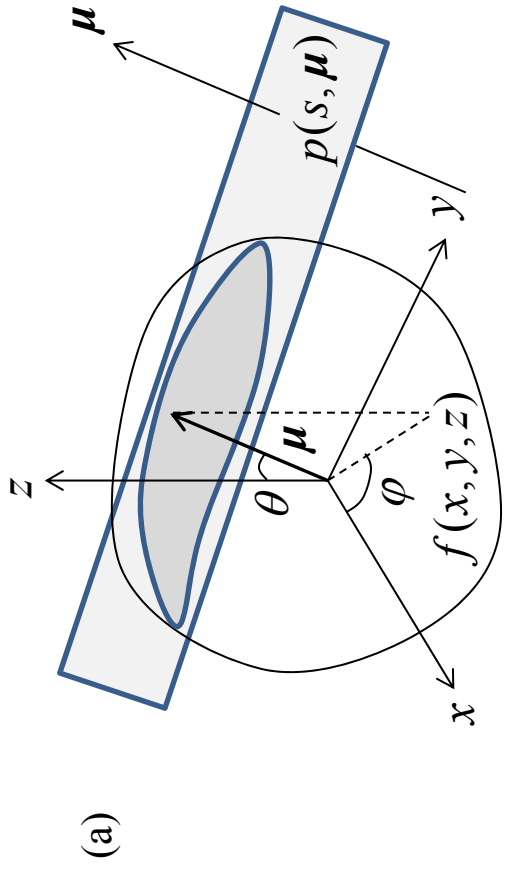

図12

# Shepp-Logan フォントム

4.5

4.5

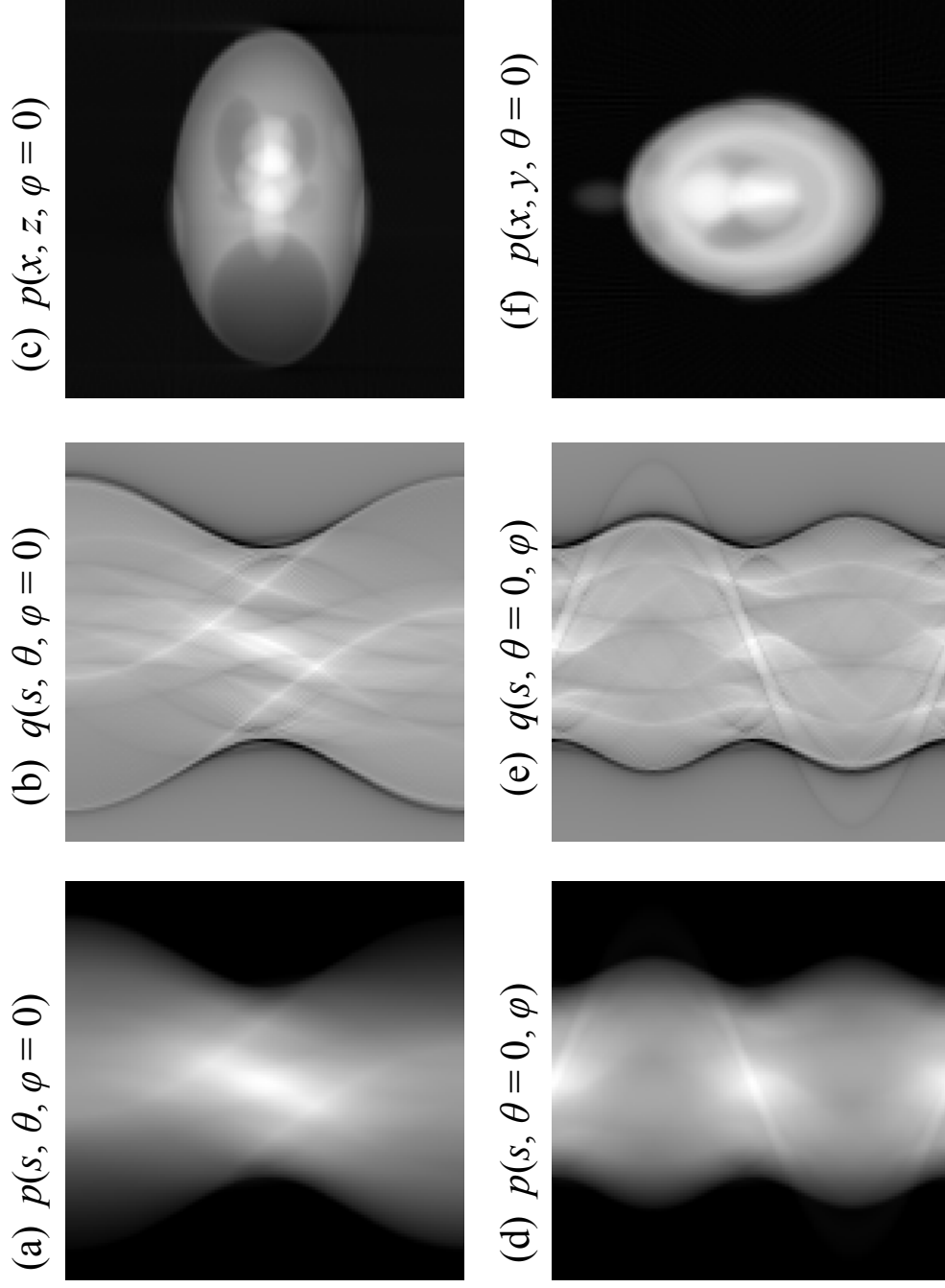
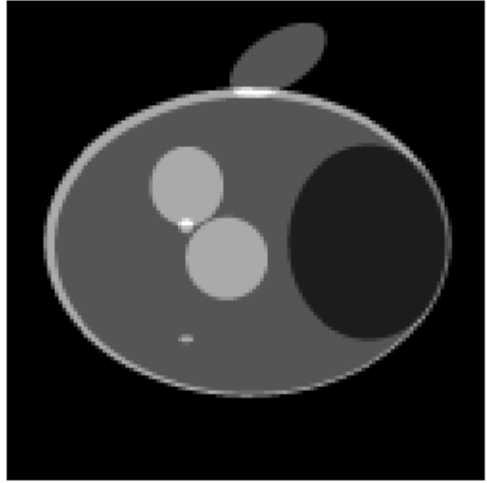
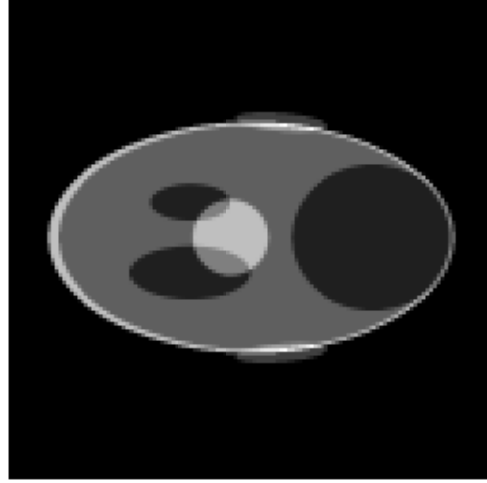
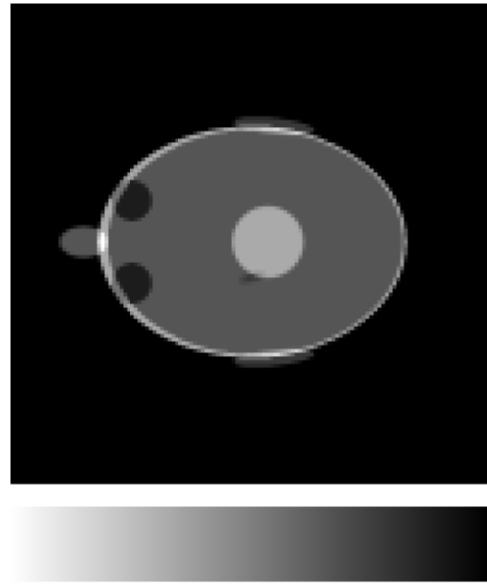

0

shepp\_transverse.img

0

shepp\_coronal.img

0

shepp\_sagittal.img

4.044144

# 再構成像

-0.2504473

3.045693

4.054316

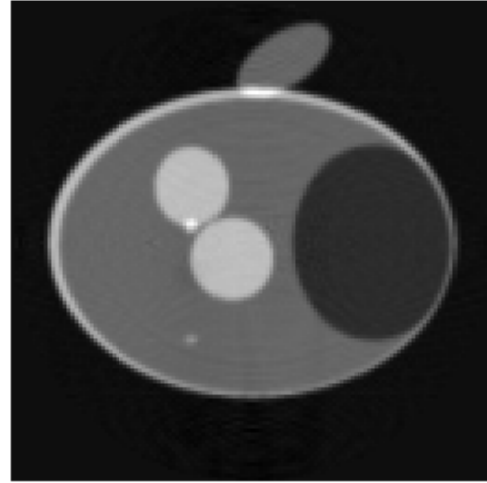
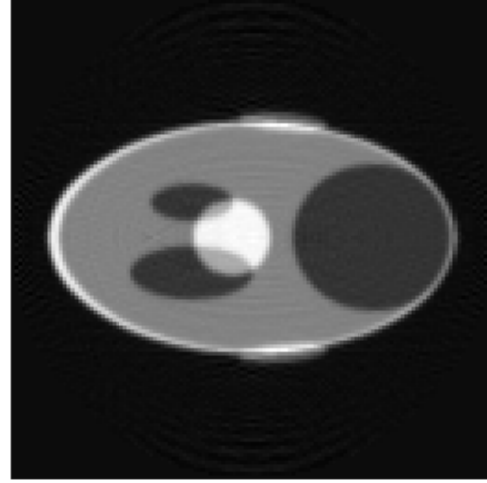
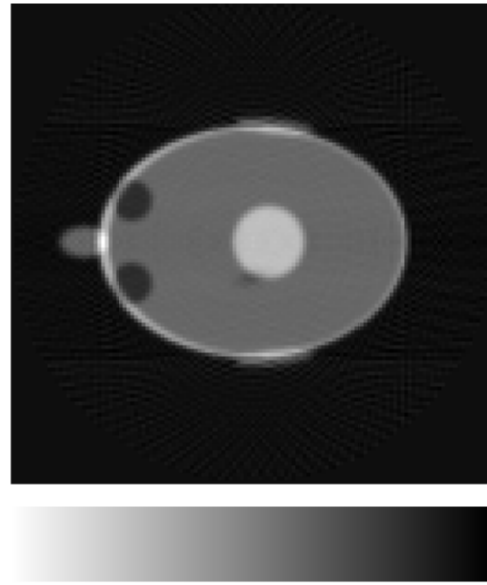

-0.2504473

transverse.img

-0.1546724

coronal.img

-0.2504473

sagittal.img

图13



图14



図15

(a) 2次元投影  $p(X, Z, \beta = 0)$

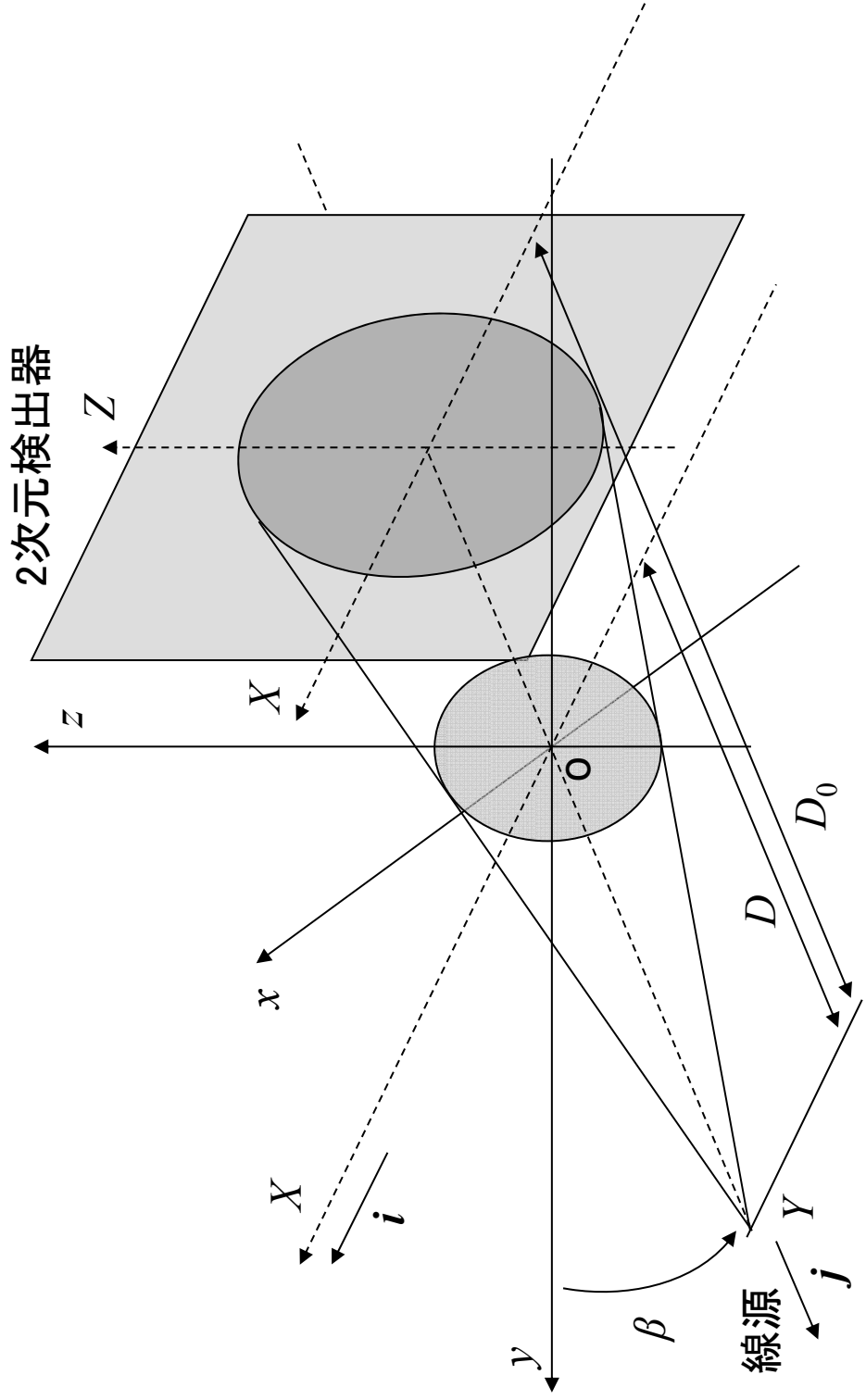

(b) フィルタ補正  $q(X, Z, \beta = 0)$

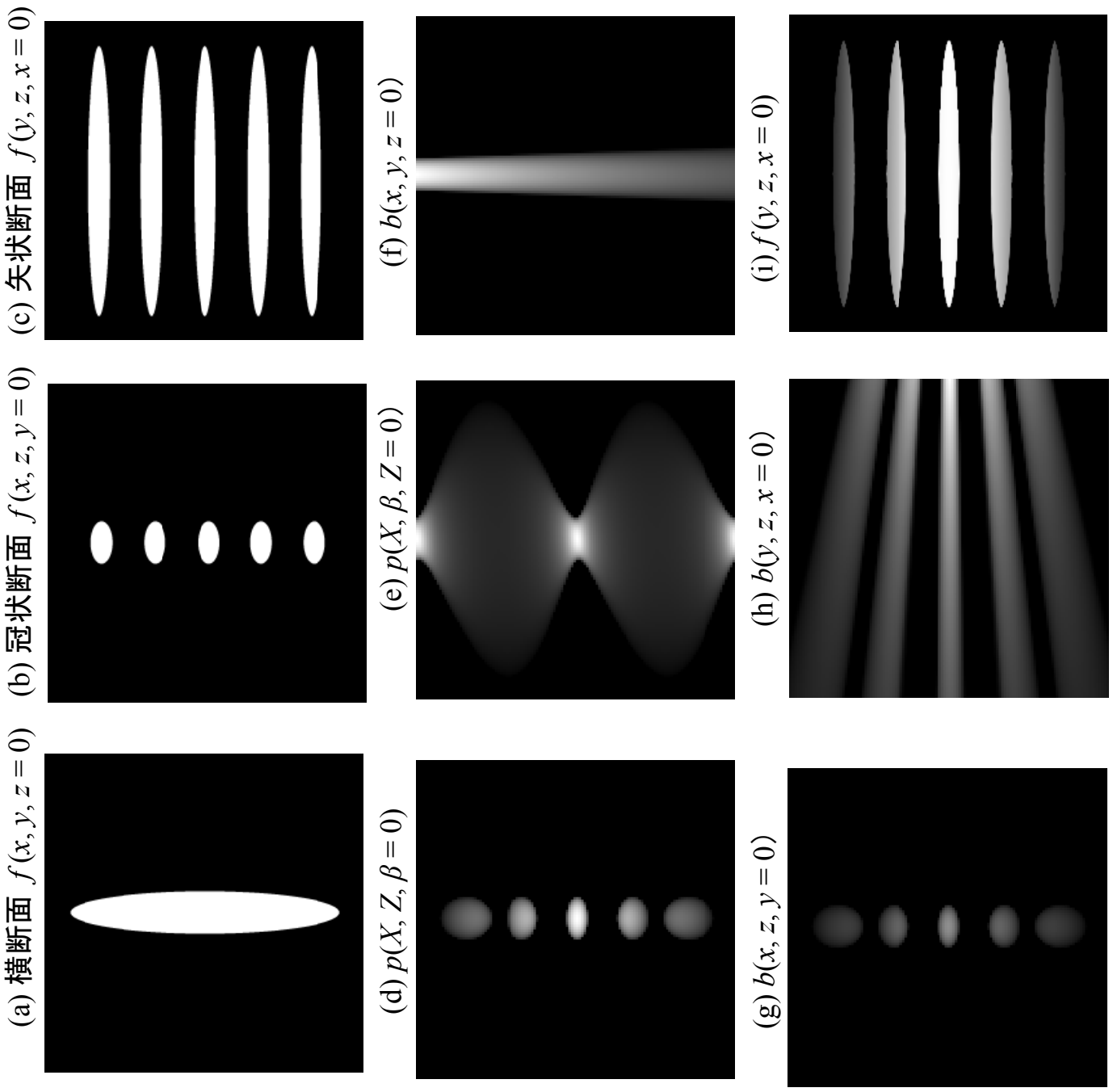
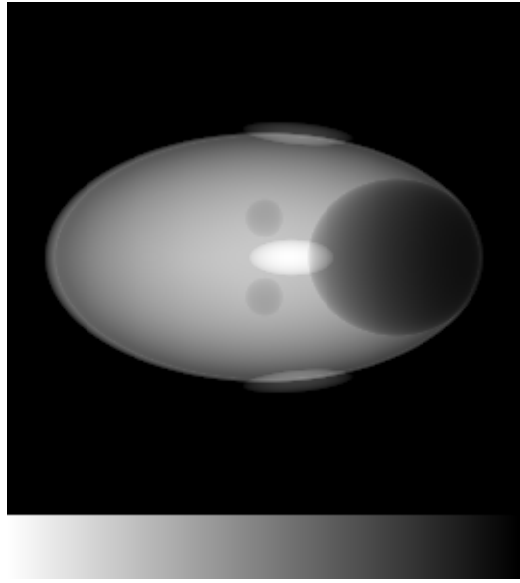
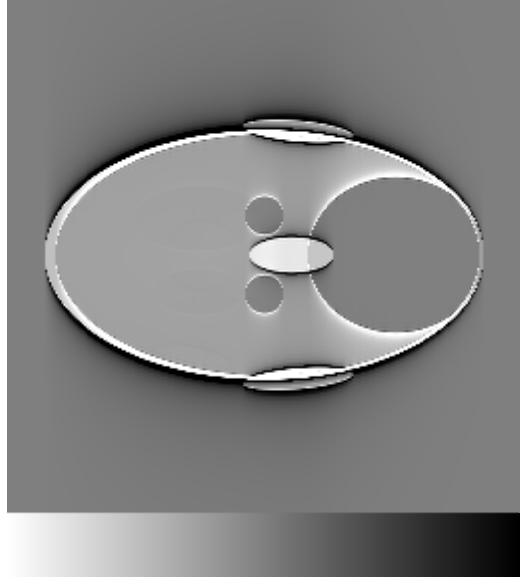

(c) フィルタ補正  $q(X, \beta, Z = 0)$

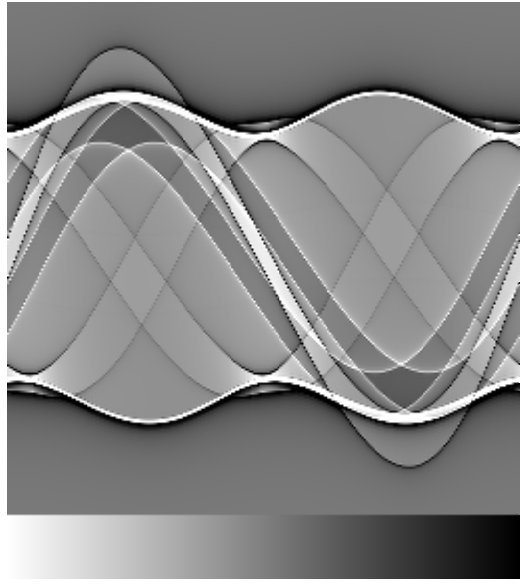

(d)

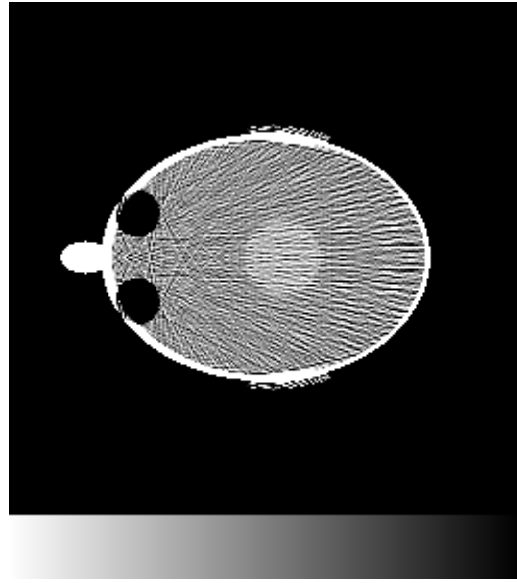

(e)

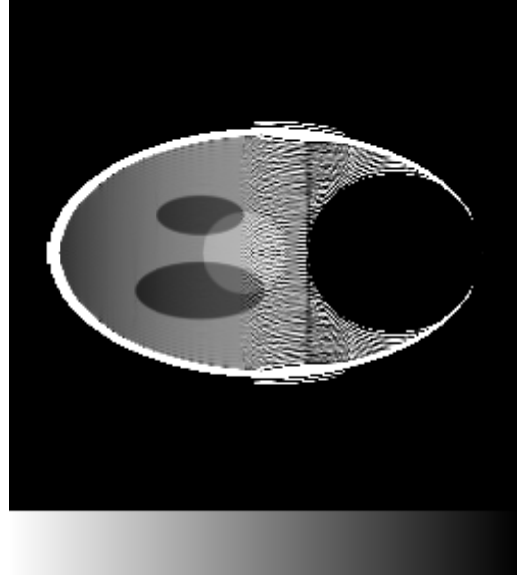

(f)



図16

210.7948



149.2547

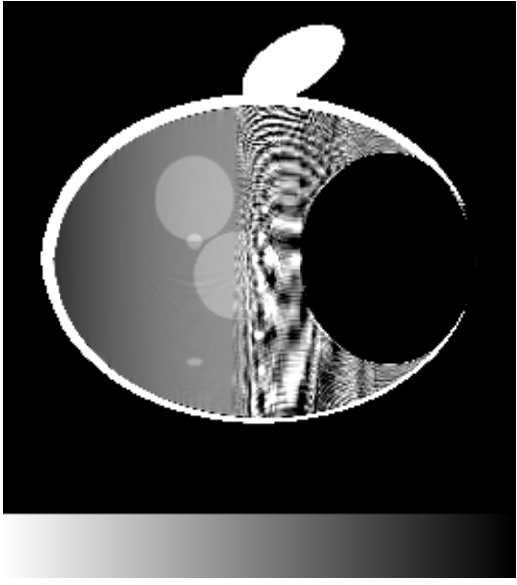
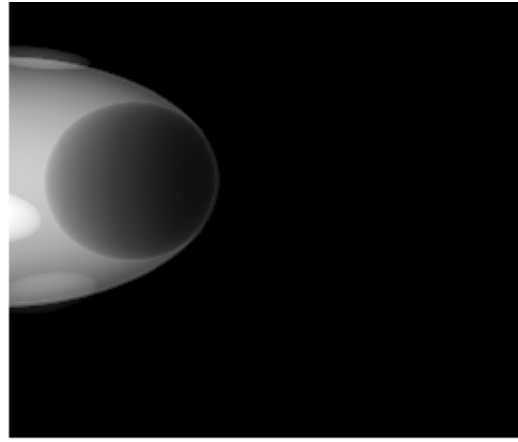
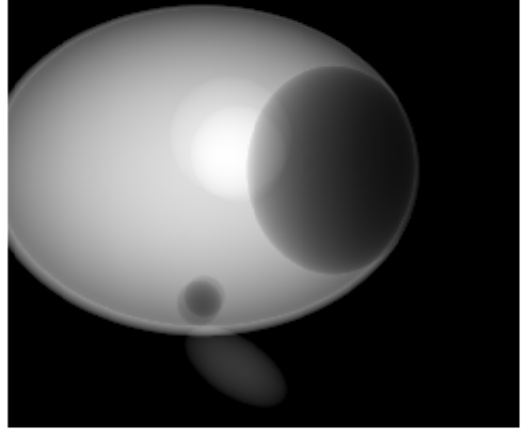

213.7366

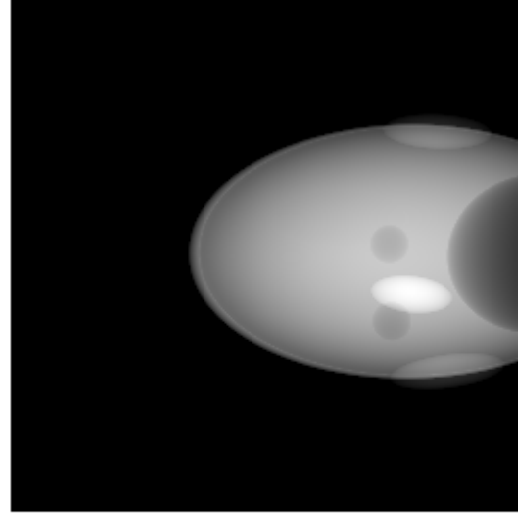

### フィルタ補正

5

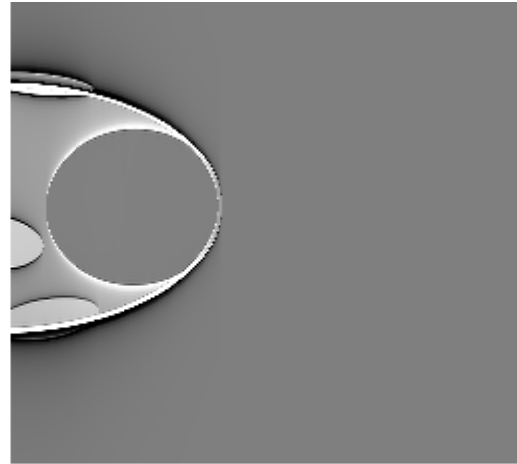

5

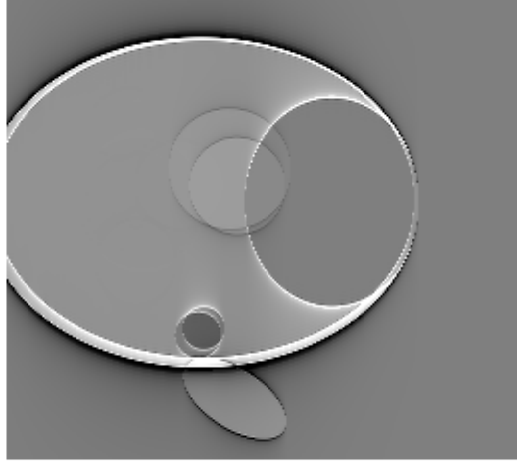

5



5

